

CPU Specifications

User Memory	50MB (Includes program, data and documentation)
Memory Type	Flash and Battery Backed RAM
Retentive Memory	1MB (Retain 800KB / Retain-Persistent 200KB)
Scan Time	550µs (5K Boolean Logic)
Interfaces	<p>USB IN: USB 2.0 (single port), Program, Monitor, Debug, Firmware Update</p> <p>ETHERNET: Two independent 10/100Mbps RJ-45 connectors</p> <p>PROTOCOLS: Modbus TCP and RTU Client/Server, EtherNet/IP Scanner/Adapter, MQTT with TLS, Email, SMTP Client</p> <p>VISUALIZATION: "WebVisu" (Web Server)</p> <p>RS-232/485: RJ12 connector</p> <p>RS-232/485: 4-position Terminal Block</p>
Data Logging	Micro SD card slot
Hardware Topologies	<p>Four (4) Base Groups: Four (4), Seven (7), Eleven (11), and Fifteen (15) Slot Bases</p> <p>Supported Modules: All P2 Discrete Input and Output modules, all P2 Analog Input and Output modules, P2-04PWM</p> <p>Unsupported Modules: Remote Slaves (P2-RS) and Intelligent modules (P2-HSO, P2-HSI, P2-02HSC, and P2-SCM)</p>
IEC 61131-3 Supported Editor Types	<p>Functional Block Diagram (FBD)</p> <p>Structured Text (ST)</p> <p>Sequential Function Charts (SFC)</p> <p>Ladder Diagram (LD)</p> <p>Continuous Function Chart (CFC)</p>
Real Time Clock Accuracy	<p>±2s per day typical at 25°C</p> <p>±10s per day maximum at 60°C</p>

Document Name	Edition/Revision	Date
P2CDS-622-DS	1st Edition, Rev A	11/16/2023

Copyright 2023, AutomationDirect.com Incorporated/All Rights Reserved Worldwide.

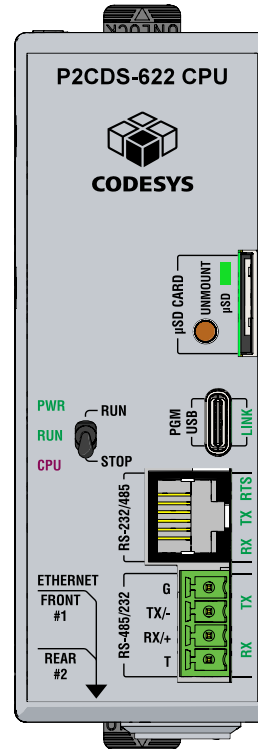

P2CDS-622 CPU

The P2CDS-622 is a full-featured, high-performance CPU for use with the Productivity2000 Bases and I/O Modules.

- CPU Specifications1
- CPU Front and Bottom Panels2
- CPU Installation Procedure2
- Battery Installation Procedure3
- Micro SD Specifications3
- RS-232 Port Specifications4
- RS-485 Port Specifications4
- Ethernet Port Specifications5
- Remote I/O Port Specifications5
- USB In Port Specifications5
- Warning8
- CPU Status Indicators8
- CPU Run/Stop Switch Specifications8
- General Specifications8
- Hot Swap Information8

CPU Front and Bottom Panels

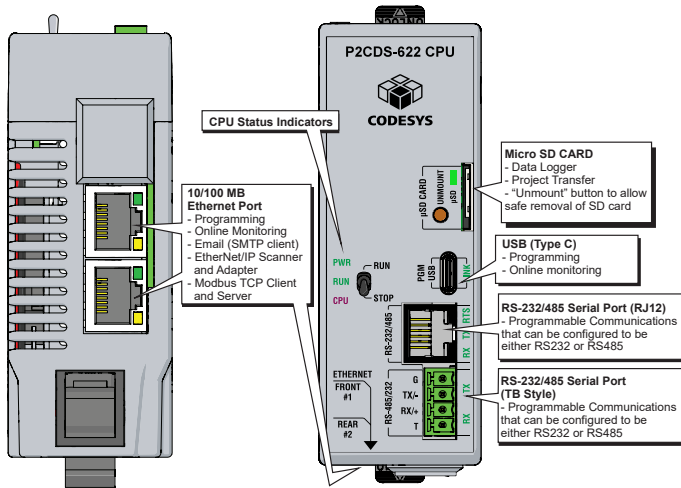

CPU Installation Procedure

Step One:
Unlock both locking tabs

Step Two:
Seat CPU on support platform and push towards base until circuit board is fully engaged into connector

Step Three:
Snap retaining tabs into the locked position.

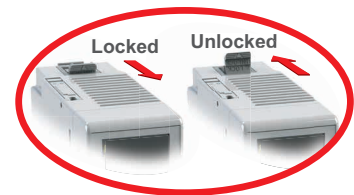

Battery Installation Procedure

Step One:

Press spring lock and swing battery compartment away from CPU.

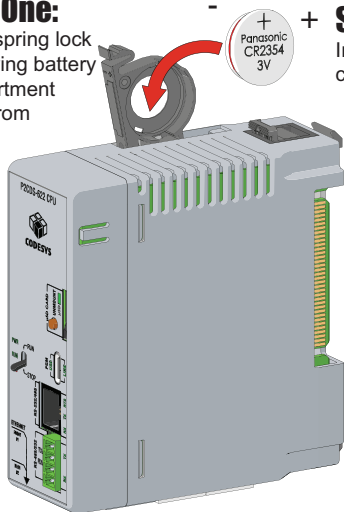

Step Two:

Insert battery and close compartment.

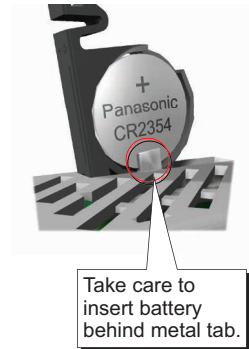

Take care to insert battery behind metal tab.

Battery (Optional)

D2-BAT-1 Coin type, 3.0 V Lithium battery, 560mA, battery number CR2354

Note: Although not needed for program backup, an uninstalled battery is included with the P2CDS-622. Install this battery if you want the CPU to retain the Time and Date along with any tags you have configured as retentive.

Micro SD Specifications

Port Name	MICRO SD			
Description	Standard Micro SD socket for data logging or program transfer			
Maximum Card Capacity	32GB			
Transfer Rate (ADATA microSDHC Class 4 memory card)	Mbps	Minimum	Typical	Maximum
	Read	14.3	14.4	14.6
	Write	4.8	4.9	5.1
Port Status LED	Green LED is illuminated when card is inserted/detected			

Micro SD Card / Unmount Button

The SD Card can be used for the Data Logging in the project.

When an SD Card is inserted, the "µSD" LED will flash green a few times then stay on steady green.

The "Unmount" button is pressed prior to removing the SD card. When pressed, the µSD flashes momentarily during the unmounting and then will be off indicating it is safe to remove the SD Card.

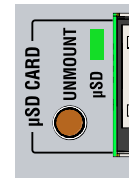

Port Specifications

RS-232 Specifications

TXD	RS-232 Transmit output
RXD	RS-232 Receive input
RTS	Handshaking output for modem control (RJ12 Only)
GND	Logic ground
Maximum Output Load (TXD/RTS)	3k Ω , 1000 pf
Minimum Output Voltage Swing	$\pm 5V$
Output Short Circuit Protection	$\pm 15mA$

RJ12 Connector

Description	Programmable RS232/485 Port
	<ul style="list-style-type: none"> - Non-isolated RS-232 DTE port connects the CPU as a Modbus/ASCII master or slave to a peripheral device. Includes ESD and built in surge protection - Non-isolated RS-485 port connects the CPU as a Modbus/ASCII master or slave to a peripheral device. Includes ESD/EFT protection and automatic echo cancellation when transmitter is active
Data Rates	Selectable, 1200, 2400, 4800, 9600, 19200, 33600, 38400, 57600, and 115200
+5V Cable Power	210mA maximum at 5V, $\pm 5\%$. Reverse polarity and overload protected.
Port Status LED	Green LEDs illuminated when active for TXD, RXD and RTS
Cable Options	EA-MG-PGM-CBL D2-DSCBL USB-RS232 with D2-DSCBL FA-CABKIT



6-pin RJ12 Female Modular Connector

Pin #	RS232	RS485
6	GND	GND
5	RTS	
4	TXD	TXRX-
3	RXD	TXRX+
2	+5V, 210mA	Do not connect
1	GND	GND

RS-485 Specifications

TXD+/RXD+	RS-485 transceiver high
TXD-/RXD-	RS-485 transceiver low
GND	Logic Ground
Input Impedance	19k Ω
Termination Resistance (TB Jumper Wire "T" to "+")	120 Ω . To use, add jumper between pin 1 and pin 2. Resistor is internally connected between pins 1 and 3.
Maximum Load	50 transceivers, 19k Ω each, 60 Ω termination
Output Short Circuit Protection	$\pm 250mA$, thermal shut-down protection
Electrostatic Discharge Protection	Contact $\pm 4KV$, Air $\pm 8KV$ per IEC61000-4-2 Cable is installed for testing
Electrical Fast Transient Protection	$\pm 1KV$ per IEC61000-4-4
Minimum Differential Output Voltage	1.5 V with 60 Ω load
Fail Safe Inputs	Logic high input state if inputs are connected
Maximum Common Mode Voltage	-7.5 V to 12.5 V

4 Position Terminal Block

Description	Programmable RS232/485 Port
	<ul style="list-style-type: none"> - Non-isolated RS-232 DTE port connects the CPU as a Modbus/ASCII master or slave to a peripheral device. Includes ESD and built in surge protection - Non-isolated RS-485 port connects the CPU as a Modbus/ASCII master or slave to a peripheral device. Includes ESD/EFT protection and automatic echo cancellation when transmitter is active
Data Rates	Selectable, 1200, 2400, 4800, 9600, 19200, 33600, 38400, 57600, and 115200
Port Status LED	Green LED illuminated when active for TXD and RXD
Cable Options	Go to AutomationDirect.com for RS-232 and RS-485 cables.

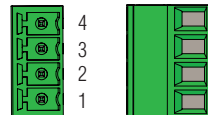

Pin #	RS232	RS485
4	GND	GND
3	TXD	TXRX-
2	RXD	TXRX+
1	Do not connect	TERMINATE

Port Specifications

Ethernet Specifications	
Port Name	ETHERNET
Description	Standard transformer isolated Ethernet port with built-in surge protection for programming, online monitoring, firmware, MQTT, Email (SMTP client), Modbus/TCP client/server connections (fixed IP or DHCP) and Ethernet/IP Scanner/Adapter connections.
Transfer Rate	RJ45 Yellow LED Off = 10Mbps / On = 100 Mbps
Port Status LED	RJ45 Green LED Solid when network LINK is established. Flashes when port is active (ACT).

USB C Specifications	
Port Name	USB C
Description	Standard USB C Slave input for programming and online monitoring, with built-in surge protection.
Transfer Rate	480Mbps
Port Status LED	Green LED is illuminated when LINK is established to programming software.
Cables	USB Type A to USB Type C: 6ft. cable part # USB-CBL-AC6

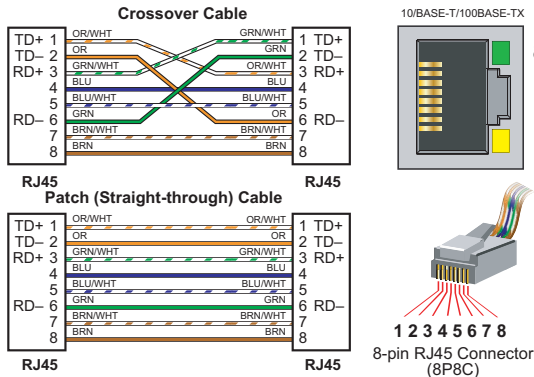

This page left blank intentionally.

This page left blank intentionally.

WARNING: To minimize the risk of potential safety problems, you should follow all applicable local and national codes that regulate the installation and operation of your equipment. These codes vary from area to area and it is your responsibility to determine which codes should be followed, and to verify that the equipment, installation, and operation are in compliance with the latest revision of these codes.

Equipment damage or serious injury to personnel can result from the failure to follow all applicable codes and standards. We do not guarantee the products described in this publication are suitable for your particular application, nor do we assume any responsibility for your product design, installation, or operation.

If you have any questions concerning the installation or operation of this equipment, or if you need additional information, please call Technical Support at 770-844-4200.

This publication is based on information that was available at the time it was printed. At AutomationDirect.com® we constantly strive to improve our products and services, so we reserve the right to make changes to the products and/or publications at any time without notice and without any obligation. This publication may also discuss features that may not be available in certain revisions of the product.

CPU Status Indicators

PWR	Green LED is illuminated when power is ON
RUN	Green LED is illuminated when CPU is in RUN mode
CPU	Red LED is illuminated during power ON reset, power down, or watch-dog time-out.

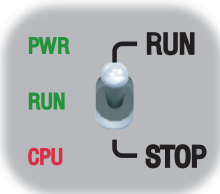

Removable Terminal Block Specifications

Part Number	PCON-KIT
Number of Positions	4 Screw Terminals
Pitch	3.5 mm
Wire Range	28–16 AWG Solid Conductor 28–16 AWG Stranded Conductor
Screw Driver Width	1/8 inch (3.175 mm) Maximum*
Screw Size	M2
Screw Torque	1.7 lb-in (0.4 N·m)

*Recommended Screwdriver TW-SD-MSL-1

General Specifications

Operating Temperature	0° to 60°C (32° to 140°F)
Storage Temperature	-20° to 70°C (-4° to 158°F)
Humidity	5 to 95% (non-condensing)
Altitude	2,000 meters max
Pollution Degree	2
Environmental Air	No corrosive gases permitted
Vibration	IEC60068-2-6 (Test Fc)
Shock	IEC60068-2-27 (Test Ea)
Overvoltage Category	II
Heat Dissipation	4800mW
Enclosure Type	Open Equipment
Module Location	Controller slot in the local base in a Productivity2000 System
Weight	139g (4.9 oz)
Agency Approvals	UL 61010-1 and UL 61010-2-201 File E139594, Canada and USA CE (EN 61131-2 EMC, EN 61010-1 and EN 61010-2-201 Safety)*

*Meets EMC and Safety requirements. See the D.O.C. for details.

IMPORTANT!



Hot-Swapping Information

Note: This device cannot be Hot Swapped.

CPU Run/Stop Switch Specifications

RUN position	Executes user program, run-time edits possible
STOP position	Does not execute user program, normal program load position